

BSK892330M
24" Built-in SteamPro Oven

AEG

BSK892330M

24" Built-in SteamPro Oven



MASTER EVEN THE MOST COMPLEX FLAVOURS

Every meal should be an experience. With that in mind we created the SteamPro oven. It has three cooking modes - heat, steam and a combination of both. In the combination mode it will calculate exactly the right combination of heat and steam automatically.

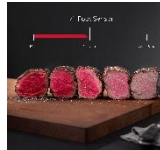

Cook to taste, every time

By precisely measuring the core temperature of your food, the Food Sensor lets you know when your rare, medium or well done meat is ready. As well as cooking fish and vegetables just the way you like them.



Restaurant-quality results at home

Professional chefs have long turned to 'sous vide' cooking to achieve perfect, consistent results. Sous Vide brings restaurant-quality technology into your own home, allowing you to create dishes that exceed your expectations.

OVEN FEATURES

- 70 Litre usable oven capacity
- Profi-Steam / Sous vide
- 24 cooking functions
- Electronic touch Command Wheel
- Anti-fingerprint stainless steel
- Fast heat up
- Humidity sensor
- Soft close door
- Inclined FloodLight™ focuses 100% on the food
- Isofront® Plus quadruple glazed door
- Fan controlled defrosting
- LED display
- Base heat finishing
- Food sensor
- Count up timer
- Delay timer, minute minder, Set+Go
- Conversion chart on inner door

TECHNICAL SPECS





















- Steam clean
- 3500 Watts, 240v, 20AMPS, 60Hz
- Water Tank Capacity : 950 ml
- Temperature range: 30°C – 230°C

OVEN ACCESSORIES

- Wire shelf
- Baking tray
- Trivet
- Grill / Roasting pan
- Temperature Probe
- Steam Set – perforated and unperforated food tray
- Telescopic runners

BSK892330M

PROGRAMS

	SLOW COOKING		GRILL
	KEEP WARM		GRILL + FAN
	PLATE WARMING		BOTTOM HEAT
	PRESERVING		MOIST FAN BAKING
	DRYING		FULL STEAM
	YOGURT		HUMIDITY HIGH PRO
	DEFROST		HUMIDITY MEDIUM PRO
	AU GRATIN		HUMIDITY LOW PRO
	TRUE FAN CONVECTION COOKING		STEAM REGENERATING
	TRUE FAN + BOTTOM HEAT		SOUSVIDE COOKING
	CONVENTIONAL COOKING		BREAD COOKING
	BOTTOM + GRILL + FAN		DOUGH PROVING

BSK892330M

SPECIFICATIONS

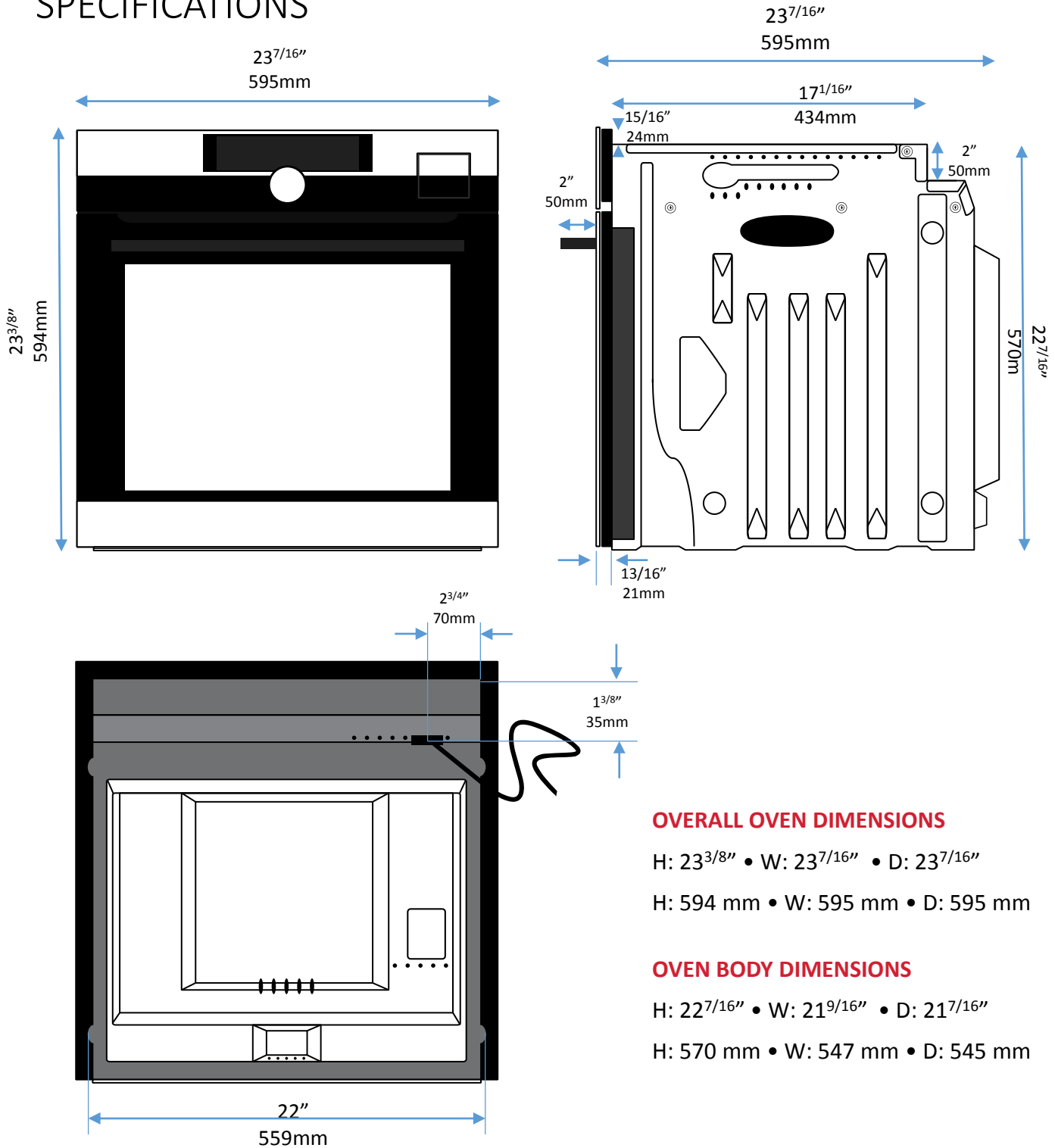

OVERALL OVEN DIMENSIONS

H: $23\frac{3}{8}"$ • W: $23\frac{7}{16}"$ • D: $23\frac{7}{16}"$

H: 594 mm • W: 595 mm • D: 595 mm

OVEN BODY DIMENSIONS

H: $22\frac{7}{16}"$ • W: $21\frac{9}{16}"$ • D: $21\frac{7}{16}"$

H: 570 mm • W: 547 mm • D: 545 mm

BSK892330M

DIMENSIONS + CUT-OUTS

OVEN DIMENSIONS

- H: 22⁷/₁₆" • W: 21⁹/₁₆" • D: 21⁷/₁₆"
- H: 570 mm • W: 547 mm • D: 545 mm

CUT-OUT DIMENSIONS

- H: min. 22¹³/₁₆" x W: min. 22¹/₁₆" x D: 23⁵/₈"
- H: min. 580mm x W: min. 560mm x D: 600mm

ELECTRICAL REQUIREMENTS

- 208/230 Volt, 60Hz, 20 AMP, 3500W

IMPORTANT

- AEG ovens are supplied with a 5' long electrical cable and must be hard wired to the electrical supply.
- AEG ovens use the following wires: RED & BLACK: Live Wires / GREEN: Ground / The Neutral (WHITE) wire is not required for the electrical installation.

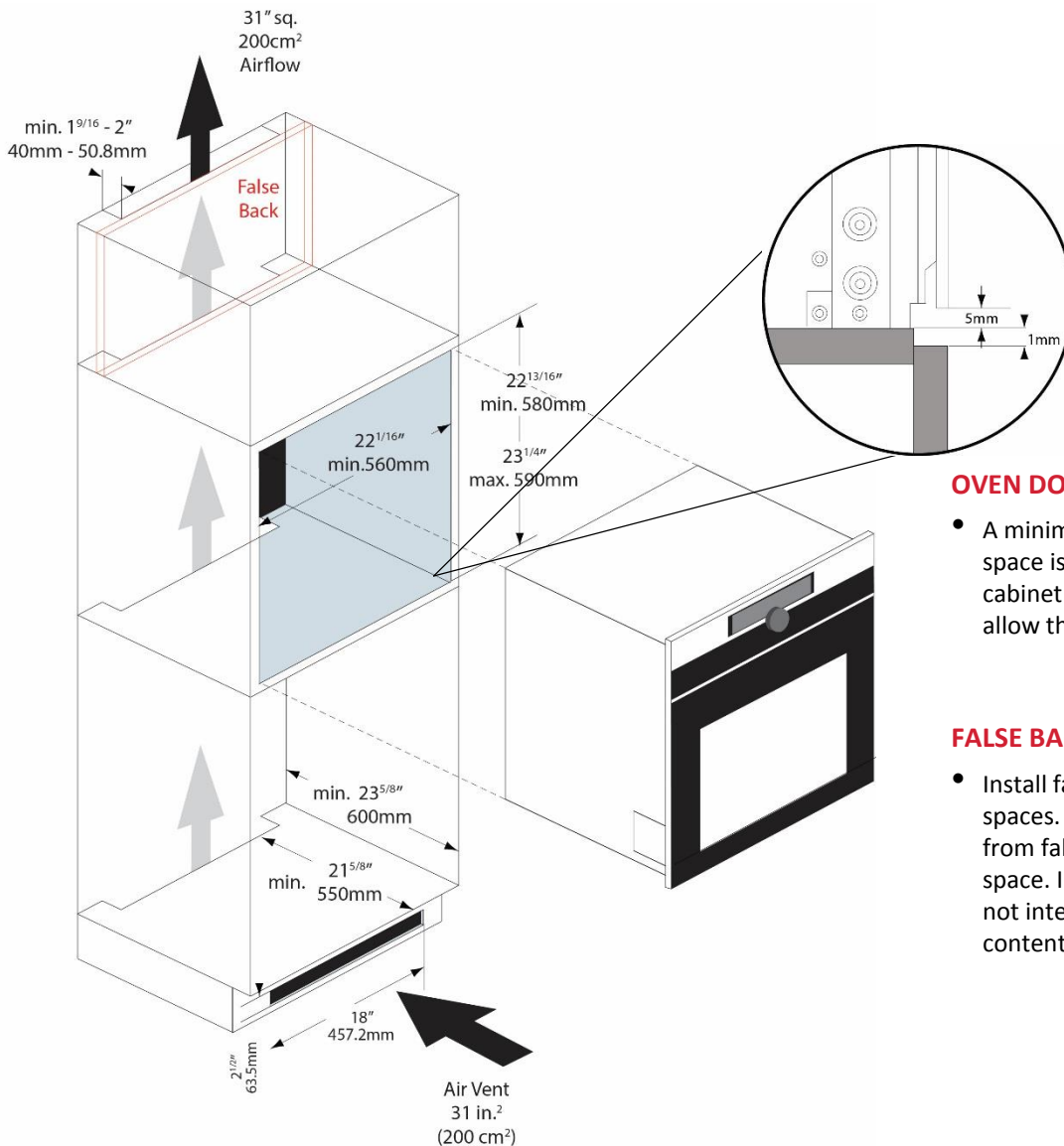

OVEN DOOR CLEARANCE

- A minimum of 1mm of clearance space is needed above the cabinet or appliance below to allow the oven door to open

FALSE BACKS

- Install false backs for storage spaces. This will prevent contents from falling through the vent space. In addition, warm air will not interfere with your stored contents

BSK892330M

DIMENSIONS + CUT-OUTS

AIR FLOW REQUIREMENTS

- If the oven is being placed under the counter, there must be a minimum gap of $1\frac{9}{16}$ " (4cm) cut out of the shelf behind the oven to allow air to flow freely.
- If sufficient air flow is not provided, the life of the appliance will be shortened.
- Cut-out in the toe kick is required for adequate air flow.
- Bottom vent grill (7427640) available.

OVEN DOOR CLEARANCE

- A minimum of 1mm of clearance space is needed above the cabinet or appliance below to allow the oven door to open

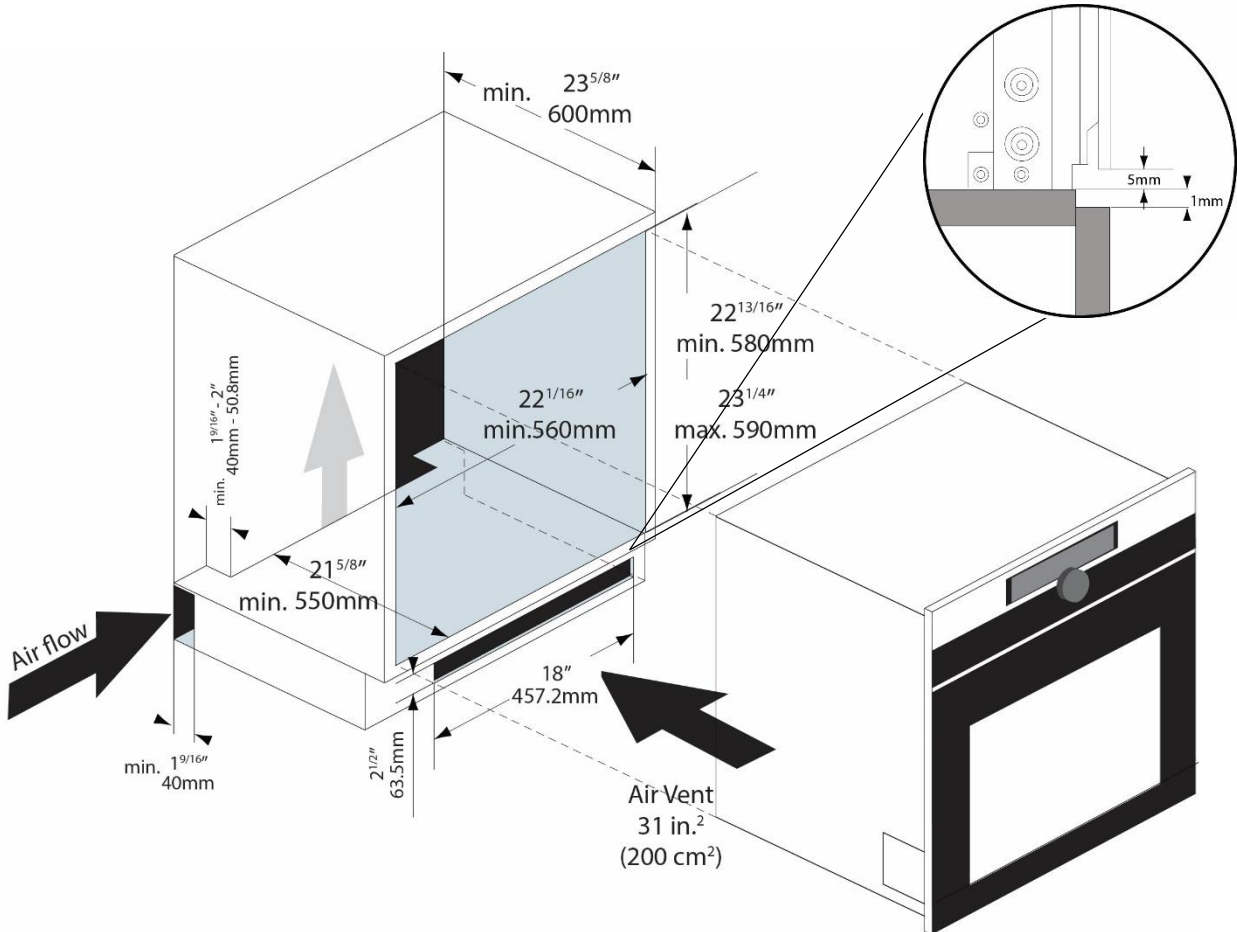

AEG

AEG Appliances are designed and manufactured to the highest standards. Each appliance is covered by a comprehensive 2-year parts and labour warranty.

Refer to product warranty policy for complete terms and conditions.

FOR PARTS AND SERVICE

Euro-Parts & Service

39822 Belgrave Road, Belgrave, ON. N0G 1E0

1 800 678 8352 (Canada) • 1 800 561 4614 (U.S.)

www.euro-parts.ca • parts@euro-parts.ca • service@euro-parts.ca

AEG appliances are imported and distributed in North America by Euro-Line Appliances Inc. For more information, please visit one of our showrooms or

www.euro-line-appliances.com www.elawest.com

EURO-LINE APPLIANCES INC.

871 Cranberry Court
Oakville, ON L6L 6J7 Canada
905 829 3980
1 800 421 6332

marketing@euro-line-appliances.com

EURO-LINE APPLIANCES WEST INC.

2912 West 4th Avenue
Vancouver, BC V6K 1R2 Canada
604 235 3980
1 855 ELA WEST (352.9378)

info@elawest.com

